

- B. Install Nut Plate and secure with 1/4" screw furnished.
  - C. Attach Frame to luminaire feeding power leads through Frame tube. Secure with (2) 3/8" bolts and lockwashers.
  - D. Mount Frame/Luminaire Assembly to pole with (2) 3/8" bolts and lockwashers. If a round pole, install Round Pole Adaptor.
  - E. Install cover over Frame and secure with #8-32 Screw.
  - F. Splice power leads to incoming power. Install pole cap.
- Strain relief for incoming power must be provided in the pole top by the customer.

**RELAMPING, CLEANING AND LIGHT DISTRIBUTION CHANGES**

**CAUTION**

**Risk of burn**

- Allow lamp/fixture to cool before handling

Use only lamps specified on nameplate. Observe lamp manufacturer's recommendations and restrictions on lamp operation, particularly ballast type, burning position, etc.

**To Open Lens Door**

Loosen (3) 1/4 turn fasteners by turning CCW. Phillips screw driver required. Lens door is hinged on pole side.

**To Remove the Lens Door**

Open to the position shown, lift and slide forward.

**To Remove or Rotate the Reflector**

Reflector may be removed to gain access to ballast and wiring, or rotated 90° CW or CCW to orient light distribution by loosening screws at each of (4) keyhole slots in reflector plate assembly. Assembly is tethered to luminaire. If it is necessary to detach the assembly, remove screw that holds tether to reflector plate.

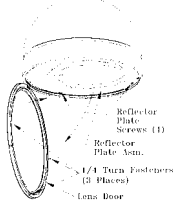

**BALLAST TRAY REMOVAL AND INSTALLATION**

Open lens door and remove Reflector plate assembly per instructions above.

**To Remove**

Disconnect incoming power and lamp leads at the electrical connectors. Loosen (2) 1/4" bolts, pull tray out and drop to clear keyhole slots.

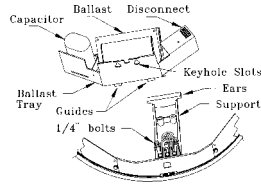

**CAUTION:** Be prepared to support the weight of the ballast during removal.

**To Install**

Locate guide to each side of support. Slide tray up under ears till 1/4" bolts can engage keyhole slots, push in and up until tray is sitting on ledges of support. Tighten 1/4" bolts.

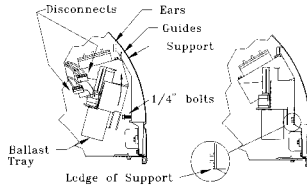

**WIRING**

**IF SINGLE VOLTAGE:**

All single voltage ballasts are pre-wired such that user need only connect the supply conductors.

**IF MULTIVOLT: (120/208/240/277)**

Connect the ballast lead with the insulated terminal to the desired voltage terminal as indicated on the ballast terminal nameplate.

**IF MULTIWATT:**

Multiwatt ballasts are available in various combinations of wattage. See wiring instructions on wiring tag inside the luminaire.

Removal of ballast tray may be required for access to ballast terminals. Follow instructions for ballast tray removal and installation as outlined above. Move insulated terminal to appropriate ballast terminal specified on wiring tag inside luminaire.

**CLEANING INSTRUCTIONS AND CAUTIONS**

**Internal**

Should internal reflector system require cleaning, use only non-abrasive, neutral (pH 6-8) cleaner containing no chlorinated or aromatic hydrocarbons. Rinse clean and wipe.

**External**

Clean glass lens with a mild soap and water solution, rinse clean and wipe dry.



GE Lighting Systems, Inc.

Hendersonville, NC 28793-4506

GEH-5749D

**INSTRUCTIONS**

**Dome Top Decasphere® Luminaire**

**READ THOROUGHLY BEFORE INSTALLING**

**WARNING**

**Risk of electric shock**

- Turn power off before servicing
- see instructions

Make all electrical connections in accordance with the National Electrical Code and any applicable local code requirements.

Verify that supply voltage is correct by comparing it to nameplate.

Replace power fuses only with fuses of the same type and ratings.

**GENERAL**

This luminaire is designed for use in outdoor applications and must adhere to 25°C Max ambient temperature limitation. Install and maintain it according to the following recommendations.

**CAUTION**

**Unit will fall if not installed properly**

- Follow installation instructions

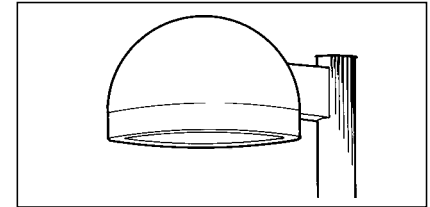
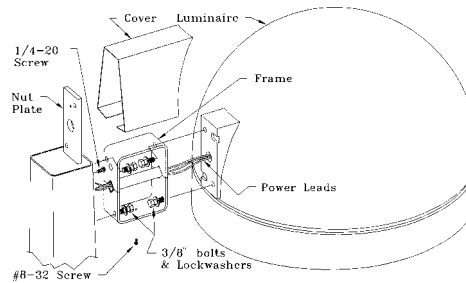

**INSTALLATION**

**Step 1**

- A. Drill pole per Fig. A if a square pole or Fig. B if a round pole.

Fig. A

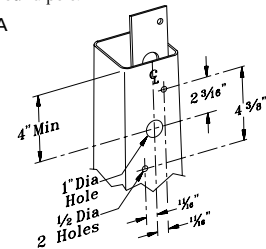
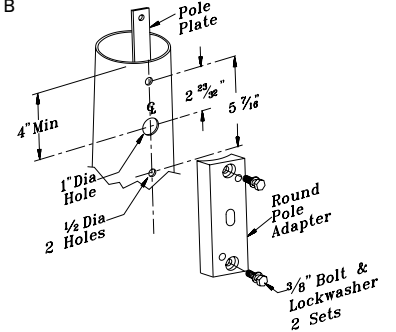

Fig. B



These instructions do not purport to cover all details or variations in equipment nor to provide for every possible contingency to be met in connection with installation, operation or maintenance. Should further information be desired or should particular problems arise which are not covered sufficiently for the purchaser's purposes, the matter should be referred to General Electric Company.

© Registered Trademark of General Electric Company